

PLEASE CHECK WWW.MOLEX.COM FOR LATEST PART INFORMATION

Part Number: [0432026107](#)
Status: **Active**
Overview: [modular_plugs_jacks](#)
Description: Modular Jack, Right Angle, Low Profile, 6/2

Documents:

[3D Model](#) [Product Specification PS-43202-001 \(PDF\)](#)
[Drawing \(PDF\)](#) [RoHS Certificate of Compliance \(PDF\)](#)

Agency Certification

CSA LR19980
 UL E107635

General

Product Family Modular Jacks/Plugs
 Series [43202](#)
 Comments Enhanced panel grounding tabs
 Component Type PCB Jack
 Magnetic No
 Overview [modular_plugs_jacks](#)
 Performance Category 3, 4
 Power over Ethernet (PoE) N/A
 Product Name RJ11

Physical

Color - Resin Black
 Durability (mating cycles max) 500
 Flammability 94V-0
 Inverted / Top Latch No
 Lightpipes/LEDs None
 Material - Metal Phosphor Bronze
 Material - Plating Mating Gold
 Material - Plating Termination Tin
 Material - Resin High Temperature Thermoplastic
 Orientation Right Angle (Side Entry)
 PCB Retention Yes
 PCB Thickness Recommended (in) 0.062 In
 PCB Thickness Recommended (mm) 1.60 mm
 Packaging Type Tray
 Pitch - Mating Interface (in) 0.050 In
 Pitch - Mating Interface (mm) 1.27 mm
 Plating min: Mating (µin) 50
 Plating min: Mating (µm) 1.25
 Plating min: Termination (µin) 100
 Plating min: Termination (µm) 2.5
 Ports 1
 Positions / Loaded Contacts 6/2
 Surface Mount Compatible (SMC) Yes
 Temperature Range - Operating -40°C to +85°C
 Termination Interface: Style Through Hole
 Wire/Cable Type N/A

Electrical

Current - Maximum per Contact 1.5A
 Shielded No
 Voltage - Maximum 125V



EU RoHS

**ELV and RoHS
 Compliant**
**REACH SVHC
 Contains SVHC: No**
**Halogen-Free
 Status**

China RoHS



**Need more information on product
 environmental compliance?**

Email productcompliance@molex.com
 For a multiple part number RoHS Certificate of
 Compliance, [click here](#)

Please visit the [Contact Us](#) section for any
 non-product compliance questions.

Search Parts in this Series

[43202Series](#)

Mates With

FCC 68 Plugs

Solder Process Data

Duration at Max. Process Temperature (seconds)	5
Lead-free Process Capability	Wave Capable (TH only)
Max. Cycles at Max. Process Temperature	1
Process Temperature max. C	260

Material Info**Reference - Drawing Numbers**

Packaging Specification	PK-43202-003
Product Specification	PS-43202-001, RPS-43202-002
Sales Drawing	SDA-43202

This document was generated on 06/07/2010

PLEASE CHECK WWW.MOLEX.COM FOR LATEST PART INFORMATION



SHIELDED MODULAR JACK SHOWN WITH PANEL GROUND OPTION 'D' AND FRONT PCB GROUND TABS.

NOTES:

- 1) MATERIAL:
 HOUSING: NYLON(PA), GLASS FILLED, UL94V-0, COLOR: SEE SHEETS 5 AND 6
 INSULATOR: NYLON(PA), GLASS FILLED, UL94V-0, COLOR: SEE SHEETS 5 AND 6
 TERMINALS: PHOSPHOR BRONZE, .012/ 0.30 THICK
 SHIELD: BRASS, .007/ 0.18 THICK
- 2) FINISH:
 TERMINALS:
 A = SELECT GOLD IN CONTACT AREA: 50 MICROINCHES / 1.27 MICROMETERS MIN.,
 *SELECT TIN IN PC TAIL AREA: 100 MICROINCHES / 2.54 MICROMETERS MIN.,
 WITH OVERALL NICKEL UNDERPLATE: 50 MICROINCHES / 1.27 MICROMETERS MIN.
 B = SELECT GOLD IN CONTACT AREA: 30 MICROINCHES / 0.76 MICROMETERS MIN.,
 *SELECT TIN IN PC TAIL AREA: 100 MICROINCHES / 2.54 MICROMETERS MIN.,
 WITH OVERALL NICKEL UNDERPLATE: 50 MICROINCHES / 1.27 MICROMETERS MIN.
 *THE PRIMARY SHIPPING CARTON WILL BE LABELED "COMPLIANT TO RoHS DIRECTIVE 2002/95/EC AND ELV ANNEX II OF DIRECTIVE 2000/53/EC".
 CARTONS WITHOUT THIS LABEL MAY CONTAIN PRODUCT WITH TIN-LEAD IN THE PC TAILS AND/OR SHIELD.
- SHIELD:
 100 MICROINCHES / 2.54 MICROMETERS NICKEL OVER 50 MICROINCHES / 1.27 MICROMETERS COPPER UNDERPLATE PCB GROUND TABS DIPPED IN TIN
- 3) PRODUCT SPECIFICATION AND PROCESSING PARAMETERS: PS-43202.
- 4) PACKAGING SPECIFICATION:
 UNSHIELDED CONNECTOR ASSEMBLIES PACKAGED IN THERMOFORMED TRAYS PER MOLEX PACKAGING SPECIFICATION PK-43202-003.
 UNSHIELDED CONNECTOR ASSEMBLIES PACKAGED IN TUBES PER MOLEX PACKAGING SPECIFICATION PK-43202-005.
 SHIELDED CONNECTOR ASSEMBLIES PACKAGED IN THERMOFORMED TRAYS PER MOLEX PACKAGING SPECIFICATION PK-43202-004.
- 5) SEE SHEETS 7 - 9 FOR P.C. BOARD LAYOUTS.
- 6) CONFORMS TO FCC REGULATION PART 68.5 FOR MODULAR JACKS.
- 7) THIS PART CONFORMS TO CLASS B REQUIREMENTS OF COSMETIC SPECIFICATION PS-45499-002.

9	L2
8	L2
7	L2
6	L4
5	L
4	K2
3	L1
2	L1
1	L4
SH	REV

DRAWING LEGEND

- SHEET 1- NOTES, DRAWING LEGEND
- SHEET 2- SHIELDED MODULAR JACK W/ BOTTOM GROUND TABS
- SHEET 3- SHIELDED MODULAR JACK W/O BOTTOM GROUND TABS
- SHEET 4- UNSHIELDED MODULAR JACK
- SHEET 5- PART NUMBER CHARTS
- SHEET 6- PART NUMBER CHARTS
- SHEET 7- FOOTPRINT LAYOUT FOR 4 POSITION HOUSING
- SHEET 8- FOOTPRINT LAYOUT FOR 6 POSITION HOUSING
- SHEET 9- FOOTPRINT LAYOUT FOR 8 POSITION HOUSING

OBS COLORED JACKS EC NO: UCP2008-1189 DRAWN:JBELL 2007/11/30 CHKD:LSCHMIDT 2008/02/20 APPR:FSM/TH 2008/03/04	DESCRIPTION	QUALITY SYMBOLS ▽=0 ▽=0	GENERAL TOLERANCES (UNLESS SPECIFIED)	DIMENSION STYLE IN/MM	SCALE 4:1	DESIGN UNITS INCH	THIRD ANGLE PROJECTION
			4 PLACES ±--- ±--- 3 PLACES ±--- ±.010 2 PLACES ±0.25 ±.014 1 PLACE ±0.36 ±---	DRAWN BY JTR	DATE 1993/03/31	TITLE ULTRA LOW PROFILE RIGHT ANGLE MODULAR JACK ASSEMBLY	
			ANGULAR ±1/2°	CHECKED BY JTR	DATE 1993/03/31		
			DRAFT WHERE APPLICABLE MUST REMAIN WITHIN DIMENSIONS	APPROVED BY RAS	DATE 1993/03/31	MATERIAL NO. SEE SHTS 5&6	DOCUMENT NO. SDA-43202
L4	REV			SIZE C	THIS DRAWING CONTAINS INFORMATION THAT IS PROPRIETARY TO MOLEX INCORPORATED AND SHOULD NOT BE USED WITHOUT WRITTEN PERMISSION		

UNSHIELDED MODULAR JACKS

SIZE 8, LOADED 10 SHOWN

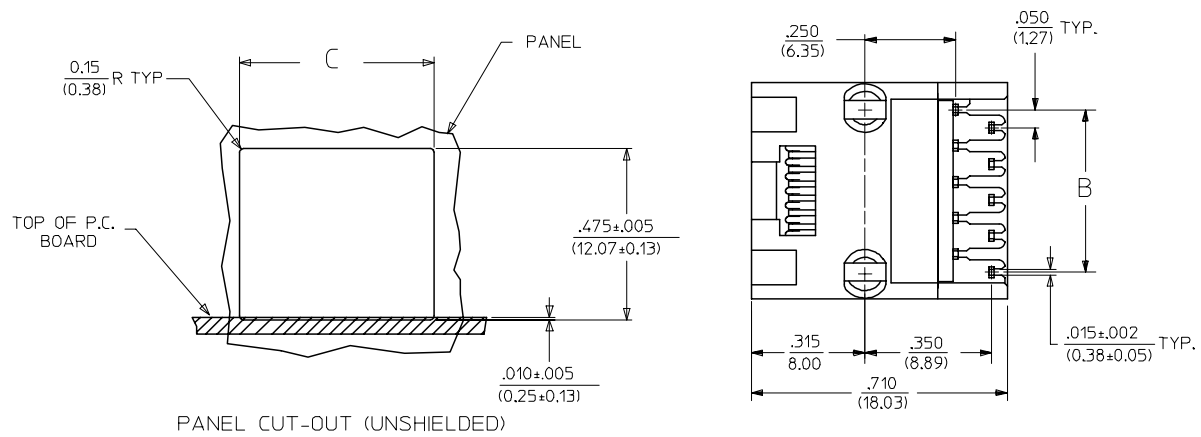
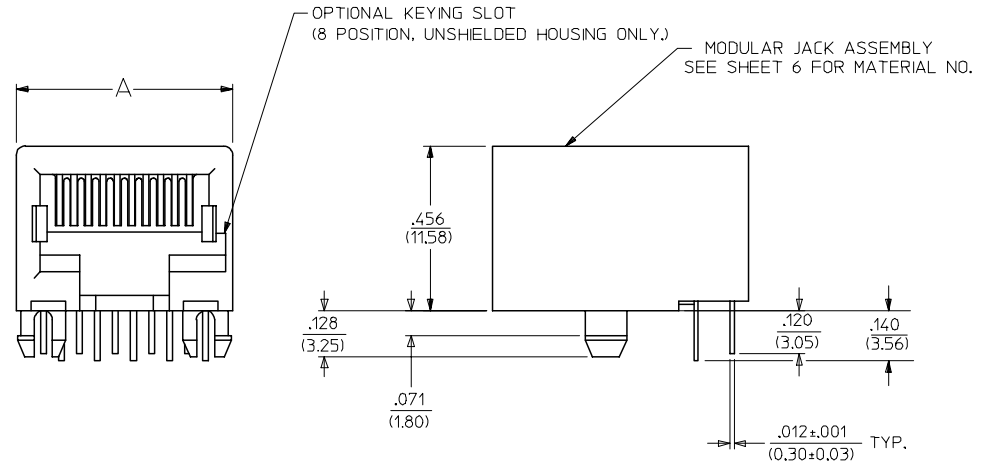

PANEL CUT-OUT (UNSHIELDED)

HOUSING SIZE	LOADED CIRCUITS	A	B	C
4	4	.440 (11.18)	.150±.005 (3.81±0.13)	.460±.005 (11.68±0.13)
4	2	.440 (11.18)	.050±.005 (1.27±0.13)	.460±.005 (11.68±0.13)
6	6	.520 (13.21)	.250±.005 (6.35±0.13)	.540±.005 (13.72±0.13)
6	4	.520 (13.21)	.150±.005 (3.81±0.13)	.540±.005 (13.72±0.13)
6	2	.520 (13.21)	.050±.005 (1.27±0.13)	.540±.005 (13.72±0.13)
8	10	.600 (15.24)	.450±.005 (11.43±0.13)	.620±.005 (15.75±0.13)
8	8	.600 (15.24)	.350±.005 (8.89±0.13)	.620±.005 (15.75±0.13)
8	6	.600 (15.24)	.250±.005 (6.35±0.13)	.620±.005 (15.75±0.13)
8	4	.600 (15.24)	.150±.005 (3.81±0.13)	.620±.005 (15.75±0.13)
8	2	.600 (15.24)	.050±.005 (1.27±0.13)	.620±.005 (15.75±0.13)



SEE SHEET ONE FC NO: UCP2004-1194 DRWN: LSCHMIDT 2004/01/02 CHKD: LSCHMIDT 2004/01/05 APPR: FLSMITH 2004/01/09 K2	QUALITY SYMBOLS -0 -0	GENERAL TOLERANCES (UNLESS SPECIFIED) mm INCH 4 PLACES ± --- ± --- 3 PLACES ± --- ± .010 2 PLACES ± 0.25 ± .014 1 PLACE ± 0.36 ± --- ANGULAR ±1/2°		SCALE 4:1	DESIGN UNITS INCH	THIRD ANGLE PROJECTION	REVISE ON CAD ONLY	
		DIMENSION STYLE IN/MM		DRAWN BY JTR	DATE 1993/03/31	ULTRA LOW PROFILE RIGHT ANGLE MODULAR JACK ASSEMBLY		
		DRAFT WHERE APPLICABLE MUST REMAIN WITHIN DIMENSIONS		CHECKED BY JTR	DATE 1993/03/31			
		THIS DRAWING CONTAINS INFORMATION THAT IS PROPRIETARY TO MOLEX INCORPORATED AND SHOULD NOT BE USED WITHOUT WRITTEN PERMISSION		MOLEX MOLEX INCORPORATED		MATERIAL NO. SEE SHT 6	DOCUMENT NO. SDA-43202	SHEET NO. 4 OF 9

SHIELDED MODULAR JACKS W/O BOTTOM GROUND TABS (SHEET 3)

UNSHIELDED MODULAR JACKS- (SHEET 4)

ASSEMBLY MATERIAL NUMBER	CONNECTOR SIZE	NUMBER OF CIRCUITS	SIDE/TOP PANEL GROUND TAB OPTION	PCB GROUND TAB OPTION	TERMINAL PLATING OPTION	PACKAGING	HOUSING COLOR
43202-8800	8	10	E	FRONT POSITION	A	TRAY	BLACK
43202-8801	8	10	F	FRONT POSITION	A	TRAY	
43202-8802	8	10	G	FRONT POSITION	A	TRAY	
43202-8803	8	10	H	FRONT POSITION	A	TRAY	
43202-8808	8	10	E	REAR POSITION	A	TRAY	
43202-8809	8	10	F	REAR POSITION	A	TRAY	
43202-8810	8	10	G	REAR POSITION	A	TRAY	
43202-8811	8	10	H	REAR POSITION	A	TRAY	
43202-8816	8	8	E	FRONT POSITION	A	TRAY	
43202-8817	8	8	F	FRONT POSITION	A	TRAY	
43202-8818	8	8	G	FRONT POSITION	A	TRAY	
43202-8819	8	8	H	FRONT POSITION	A	TRAY	
43202-8824	8	8	E	REAR POSITION	A	TRAY	
43202-8825	8	8	F	REAR POSITION	A	TRAY	
43202-8826	8	8	G	REAR POSITION	A	TRAY	
43202-8827	8	8	H	REAR POSITION	A	TRAY	

ASSEMBLY MATERIAL NUMBER	CONNECTOR SIZE	NUMBER OF CIRCUITS	TERMINAL PLATING OPTION	KEYING OPTION	PACKAGING OPTION	HOUSING COLOR
43202-4101	4	4	A	NO	TRAY	BLACK
43202-4104	4	2	A	NO	TRAY	
43202-6101	6	6	A	NO	TRAY	
43202-6102	6	6	B	NO	TRAY	
43202-6104	6	4	A	NO	TRAY	
43202-6105	6	4	B	NO	TRAY	
43202-6107	6	2	A	NO	TRAY	
43202-6110	6	6	B	NO	TUBE	
43202-8101	8	10	A	NO	TRAY	
43202-8104	8	8	A	NO	TRAY	
43202-8105	8	8	B	NO	TRAY	
43202-8113	8	8	A	YES	TRAY	
43202-8116	8	6	A	NO	TRAY	
43202-8119	8	4	A	NO	TRAY	
43202-8122	8	2	A	NO	TRAY	
43202-8504	8	8	A	NO	TUBE	
43202-8513	8	8	A	YES	TUBE	

OBS COLORED JACKS EC NO: UCP2008-1189 DRAWN: J.BELL 2007/11/30 CHKD: LSCHMIDT 2008/02/20 APPR: FSM/TH 2008/03/04	QUALITY SYMBOLS  = 0  = 0.010	GENERAL TOLERANCES (UNLESS SPECIFIED)		DIMENSION STYLE IN/MM		SCALE 4:1	DESIGN UNITS INCH	 THIRD ANGLE PROJECTION		
		4 PLACES ± --- ± ---	3 PLACES ± --- ± .010	2 PLACES ± 0.25 ± .014	1 PLACE ± 0.36 ± ---	APPROVED BY BW	DATE 2000/10/03	TITLE ULTRA LOW PROFILE RIGHT ANGLE MODULAR JACK ASSEMBLY		
		ANGULAR ± 1/2°				MATERIAL NO. SEE CHART		DOCUMENT NO. SDA-43202		SHEET NO. 6 OF 9
		DRAFT WHERE APPLICABLE MUST REMAIN WITHIN DIMENSIONS				THIS DRAWING CONTAINS INFORMATION THAT IS PROPRIETARY TO MOLEX INCORPORATED AND SHOULD NOT BE USED WITHOUT WRITTEN PERMISSION				

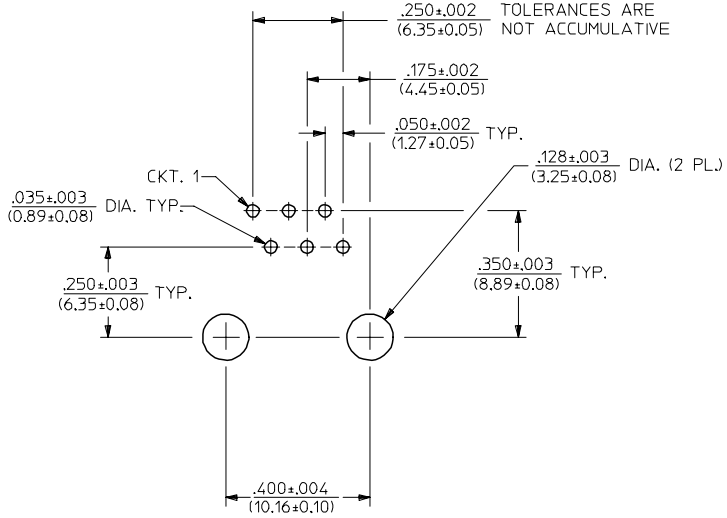

PC BOARD LAYOUT FOR 6 POSITION HOUSING

(6 CIRCUIT FOOT PRINT SHOWN)
(COMPONENT SIDE OF BOARD)

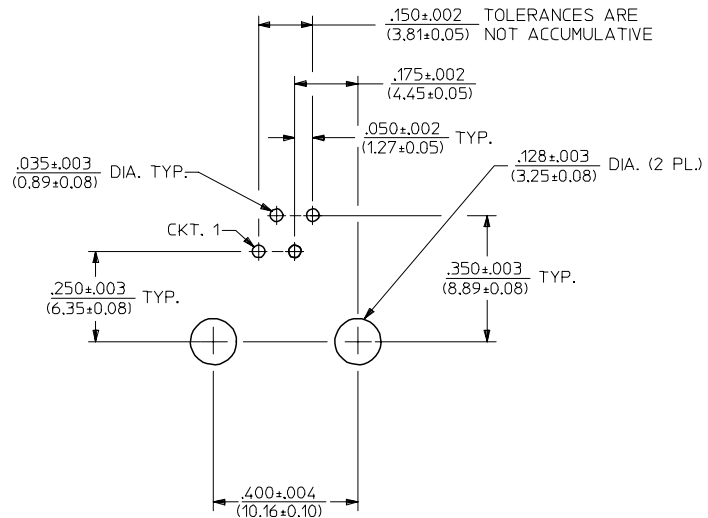

PC BOARD LAYOUT FOR 6 POSITION HOUSING

(4 CIRCUIT FOOT PRINT SHOWN)
(COMPONENT SIDE OF BOARD)

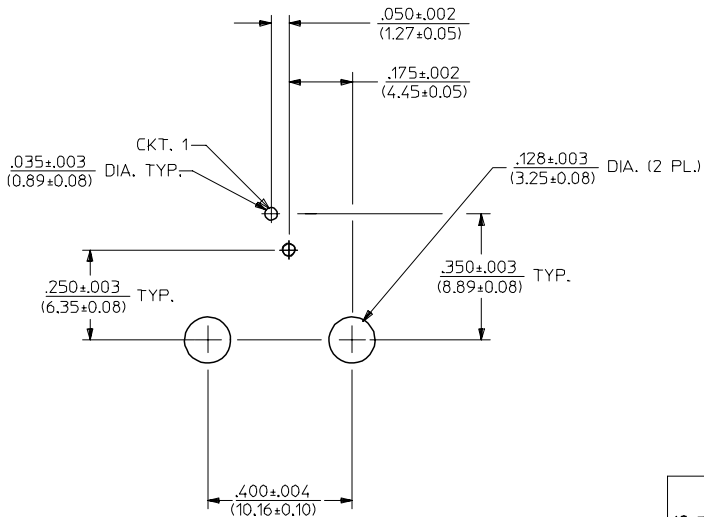

PC BOARD LAYOUT FOR 6 POSITION HOUSING

(2 CIRCUIT FOOT PRINT SHOWN)
(COMPONENT SIDE OF BOARD)

NOTES:
1. RECOMMENDED PCB THICKNESS: .062±.005/(1.57±0.13)

ADD PCB THICKNESS EC NO: UCP2005-2739 DRWN:L.SCHMIDT 2005/06/20 CHKD:ELHAG 2005/06/22 APPR:FSMITH 2005/06/23 REV L2	QUALITY SYMBOLS	GENERAL TOLERANCES (UNLESS SPECIFIED)	SCALE 4:1	DESIGN UNITS INCH	THIRD ANGLE PROJECTION	REVISE ON CAD ONLY	
	▽ - 0 ▽ - 0	mm	INCH	DIMENSION STYLE IN/MM	TITLE		
		4 PLACES ± --- ± ---	± .010	DRAWN BY L.E.LENZ	DATE 1995/03/09	ULTRA LOW PROFILE RIGHT ANGLE MODULAR JACK ASSEMBLY	
		3 PLACES ± --- ± ---	± .014	CHECKED BY JTR	DATE 1995/03/09	MOLEX MOLEX INCORPORATED	
	2 PLACES ± 0.25 ± ---	± .014	APPROVED BY RAS	DATE 1995/03/09	MATERIAL NO. SEE SHT 6	DOCUMENT NO. SDA-43202	
	1 PLACE ± 0.36 ± ---	± ---	DRAFT WHERE APPLICABLE MUST REMAIN WITHIN DIMENSIONS		SHEET NO. 8 OF 9		
THIS DRAWING CONTAINS INFORMATION THAT IS PROPRIETARY TO MOLEX INCORPORATED AND SHOULD NOT BE USED WITHOUT WRITTEN PERMISSION							